

Contents

INTRODUCTION

Welcome to CORNERED speakers

GETTING STARTED

1. Connect the cables
2. Find the perfect spot
3. Mount the speakers

DAILY USE OF YOUR SPEAKERS

A powerful experience
Cleaning and maintenance
Disposing of electrical appliances

NOTES FOR THE PROFESSIONAL INSTALLER

INSTALLING THE SPEAKER

SPECIFICATIONS

Warranty & service

DECLARATION OF CONFORMITY

Congratulations!

You are up for a great looking and great sounding experience

With the purchase of your CORNERED speakers, you can enjoy two things in one: Unique design and excellent sound.

CORNERED speakers feature a one-of-a-kind 90-degree triangular design that makes for a discreet and elegant installation anywhere in your home - in corners, on the wall, below the ceiling, on shelves and as a center and rear channel for surround sound.

But good looks aren't everything. CORNERED speakers also offers excellent sound quality. In fact, CORNERED speakers reproduce a natural three-dimensional sound stage that fills your room with sound - and strives at making listening to music one of your favorite activities.

To get the most out of your CORNERED speakers - and make the installation process as easy as possible - please take a minute to study this manual.

Enjoy!



Hans V. Madsen / Founder

Getting started

Follow 3 easy steps to install your new CORNERED speakers, and soon you'll be cornered by sound in a class of its own:

1. Connect the cables
2. Find the perfect spot
3. Mount the speakers

1. Connect the cables

Note: It is important that you install the speaker cables BEFORE mounting your new CORNERED speakers! The speakers are equipped with discreet cable terminals placed on the front baffle behind the front cover – and it is not possible to run the cables to the terminals once the speakers have been mounted.

- Remove the front cover to access the cable terminal ①
- Make sure the amplifier is turned off
- Run the speaker cable through the tube positioned at the rear of the cabinet
The cable will come out between the woofers on the front plate ②
- Connect the red plus (+) output from the amplifier to the red plus (+) cable terminal located to the right of the tube ③
- Connect the negative minus (-) output from the amplifier to the black minus (-) input terminal located to the left of the tube ④

Important notes:

- The tube allows for cables with a maximum diameter of 10mm
- For the best result, use speaker cables with a wire thickness of min. 1,5mm²
- If the red amplifier output is connected to the black speaker input (out of phase), the stereo imaging will be blurred, and the bass output will be dramatically reduced
- Make sure the terminals are screwed down tight after connecting the cables
- Always use the same type of cables for left and right speaker channels

When you have connected the cables to the terminals, pull the cables tight in the tube – and you are ready to mount the speakers.

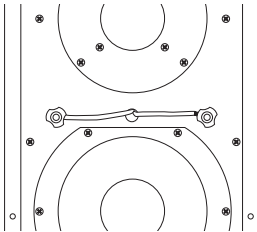
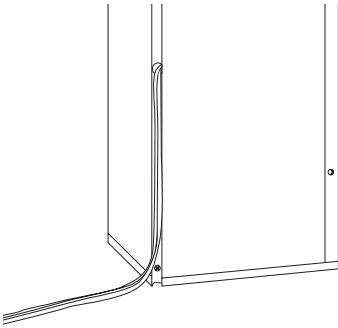
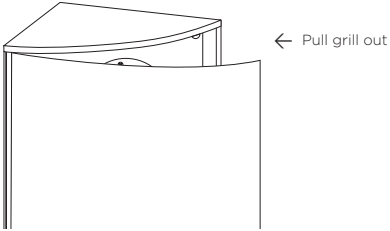

2. Find the perfect spot

Designed for versatile positioning

You've probably already found the perfect place for your new CORNERED speakers! The speakers will fit vertically in a corner, horizontally between the wall and the ceiling, above or below your TV as a center channel and of course behind your couch as rear channels. If you don't feel like mounting the speakers to the wall, you also have the option of placing them like traditional speakers on a shelf or on top of a piece of furniture.

Create a natural 3D sound stage

CORNERED speakers have a very wide dispersion of sound. To get the most out of the speakers, we recommend as a rule of thumb that you place them with a distance of minimum 2 meters and maximum 5 meters between the left and right speakers. Avoid placing objects such as furniture between the speakers and the listening position, as this will have a negative influence on the tonal balance of the sound. If you take these few precautions, your new speakers will reproduce a natural 3-dimensional sound stage – and give you a clear picture of each of the musicians and their position on the stage.

3. Mount the speakers

The C3 is simply installed by screwing through the cabinet

- Remove the front cover (you'll see the two mounting holes above and below the speaker units)
 - Place speakers in desired position
 - Mark drilling positions on the wall by **placing the mounting template where the speakers will be mounted** and shading through the 2 mounting holes
 - Drill holes in the wall and use 4mm rawlplugs and 3mm screws ①
 - **Run the speaker cable from the rear to the front speaker terminals.**
 - Reposition the speakers in desired position and mount the screws **and speaker cable**
 - Reinstall the front cover
-

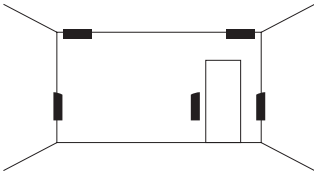

Application examples Stereo

Vertical in corner
 Vertical on wall
 Horizontal in corner

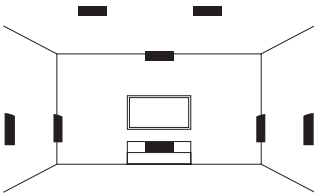

Application examples Surround

Vertical in corner as front channels
 Vertical on wall as rear channels
 Horizontal on ceiling for ATMOS
 Horizontal below TV as center channel
 *Horizontal above TV as center channel

*If you wish to have the voice coming exactly from the TV screen, you have the possibility of using two centre channels, one below and one above the TV screen.

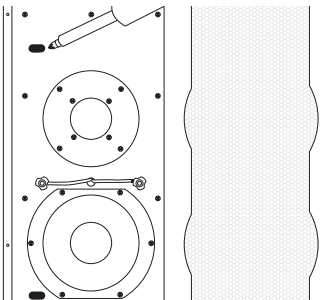

① Mounting the screws

Mounting in corners that are not exactly 90 degrees

Even if the corners in your home are not exactly 90 degrees, you can still mount your new CORNERED speakers in the corner.

- If the corner is less than 90 degrees, simply place the speaker cabinet as deep in the corner as possible. This will leave a little space behind the cabinet and the walls, but the speakers will still appear with a nice finish in the corner
- If the corner is more than 90 degrees, just mount the speaker cabinet onto the side wall - and leave some air behind the rear of the cabinet. This will not be visible from the front, and the speakers will still present themselves with a nice finish in the corner

I

Daily use of your speakers

How to get the most out of your speakers

A powerful experience

There are many cool things about your new CORNERED speakers. Among others, they can play very loud for their size and they are very reliable.

Choosing a suitable amplifier

Here's the deal: Contrary to what many people think, a small amplifier is a greater risk to the speakers than a big one! The reason being that a small amplifier, if pressed to the limits, might become unstable and produce distortion or clipping.

This will increase the power more than 10 times to the tweeter, which may cause damage. A large amplifier however, will remain in control while playing loud. As long as the signal is clean, the speakers will have no problem receiving slightly more power than they are specified for.

Important notes:

- The tone controls should be set close to the neutral position
- If you hear distortion or mechanical sounds from the speakers, chances are that your amplifier is overdriven, and volume has to be turned down
- CORNERED speakers have a nominal impedance of 8 ohm - which makes them an easy load for the amplifier and a great match for all quality amplifiers

Cleaning and maintenance

To keep up the good looks, clean the cabinet with a soft, dry micro-fiber cloth. The front cover can be vacuumed and wiped carefully with a well-wrung, lint-free cloth with a mild all-purpose cleaner. If you need to clean the speakers behind the front cover, avoid wiping the dome tweeter as it can change the geometry of the dome and reduce the sound quality significantly.

Disposing of electrical appliances

When eventually disposing of the product, do not mix it with general household waste. There is a separate collection system for used electronic products in accordance with legislation that requires proper treatment, recovery and recycling. Private households in the EU member states, Switzerland and Norway may return their used electronic products free of charge to designated collection facilities or to a retailer (if you purchase a similar new one). For countries not mentioned above, please contact your local authorities for the correct method of disposal. By doing so, you will ensure that your disposed product undergoes the necessary treatment, recovery and recycling and thus prevent potential negative effects on the environment and human health.

Notes for the professional installer

Installation

Before installing

As CORNERED top-boxes are very light, make sure that the wall structure is solid and can support the weight of the speaker before installing the speaker. Also, make sure that you comply with all local health and safety regulations.

A one-person job

The C3 is more compact and lighter than a similar wooden cabinet. At the same time, The low weight allows the products to be installed easily by one person. Drive units and crossover can be easily accessed behind the front cover, which can be removed without tools in a matter of seconds.

Safety wire

In installation terms, the CORNERED top-boxes are 'as much brackets as they are speakers,' so no safety wire is needed, just as you don't need a safety wire from the wall to a bracket.

Coverage

Wide dispersion even at high frequencies

CORNERED speakers are designed with emphasis on uniform and wide power re-sponse. Special emphasis is placed on phase through the crossover point and cone/dome geometry. As an example, the large surround of the tweeter dome ensures very wide dispersion also at high frequencies.

- One cabinet offers app 120x1200 degree dispersion.
 - Two CORNERED cabinets can be coupled together back to back and mounted flush onto walls and ceilings while offering 180 degrees of coverage with minimum phase cancellation between the cabinets
-

Recommended speaker cables

Speaker cables present the amplifier with different loads. Cables with high capacitance, high inductance and high impedance have a strong negative influence on sound quality as well as amplifier reliability. So in order to get the most out of the speaker system, avoid using thin speaker cables.

As a rule of thumb, 2 mm² (14 AWG) cable can be used for lengths up to 20 meters. 4 mm² (11 AWG) cable should be used for lengths over 20 meters. For lengths over 50 meters, some amplifiers will become unstable and sound quality and reliability will be reduced significantly. Cornered speakers will allow for a 10mm cable to be run through the cable tube, so if you use thick professional installation cable, simply remove the outer isolation material from the cable and run the separate wires to the speaker terminals (provided the cable wires have separate isolation). We recommend the Cornered CSP2 speaker cable designed to fit in corners.

Easy load

Cornered speakers have high Re min., so they are an easy load. Typical pro amplifiers will run three speakers per channel without problems.

Recommended amplifier

For professional applications we recommend amplifiers with a minimum output on level with the highest recommended amplifier output in the specifications. If used with a sub, we recommend a 24 dB Linkwitz-Riley high-pass filter at 80 - 100 Hz.

Application examples

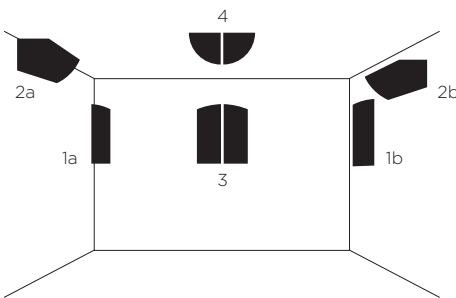

- 1a: Vertical in corner.
- 1b: Vertical on wall.
- 2a: Horizontal in corner.
- 2b: Horizontal mid-wall.
- 3: Coupled together in mid-wall position.
- 4: Coupled together in mid-ceiling position.

Specifications

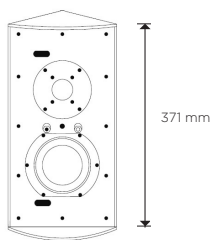
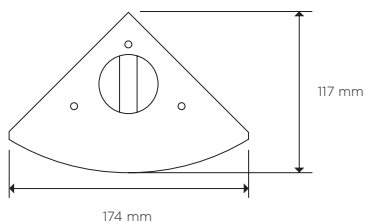
Front**Top plate****C3**

Woofer:	4" ultra long-throw
Tweeter:	1"
Power handling, IEC268:	80 watt
Power handling, peak:	320 watt
Sensitivity, 2,83V/1m:	86 dB
Maximum SPL, long term:	105 dB
Maximum SPL, peak:	111 dB
Frequency response:	70-25.000 Hz
Nominal impedance:	8 ohm
Dispersion:	120x120 degree
Weight:	2,7 kg
Measurements:	371x174x124mm

Warranty & service

For warranty information, please refer to your local CORNERED distributor or dealer. Spare parts for your CORNERED speakers are available through your local CORNERED distributor. In case you are not able to source spare parts locally, please contact us directly at info@cornered.dk.

Declaration of conformity

Manufacturer:

CORNERED Audio ApS
Roskildevej 16A
2620 Albertslund
Denmark

We, CORNERED Audio ApS, declare under our responsibility that the following product(s):

C3
Type: Speaker

...are in conformity with:

COUNCIL DIRECTIVE of 3 May 1989 on the approximation of the laws of the Member States relating to electromagnetic compatibility (89/336/EEC)

..and has been manufactured in conformity with the following national standards that implements a harmonized standard:

EN 55013

Limits and methods of measurement of radio disturbance characteristics of broadcast receivers and associated equipment.



Hans V. Madsen / Founder
01.09.2012
